

EMC Dual-Ridge horn

EH1840 (18 – 40 GHz)



SOLUTION FOR

Radiated emissions testing according to

- FCC
- MIL-STD-461
- SAE ARP 958

Main features

Technical performance

- Single linear polarization
- Smooth / balanced gain with frequency
- Low return loss / VSWR

Design

- Unique design preventing the excitation of unwanted high order modes in the aperture
 - Well defined smooth radiation pattern throughout the operational bandwidth
 - Stiff / robust and lightweight mechanical design
 - Precision machined
 - High reliability k coaxial connector
- Warranty: 3 years

Product configuration

Equipment

- Storage box
- Standard axial mounting interface
- Custom mounting interface
- Antenna tripod

Services

- Calibration
- Maintenance

Delivered documents

- Technical description document
- Calibration certificate

Included Optional

Far-field radiation pattern

— E-plane — H-plane

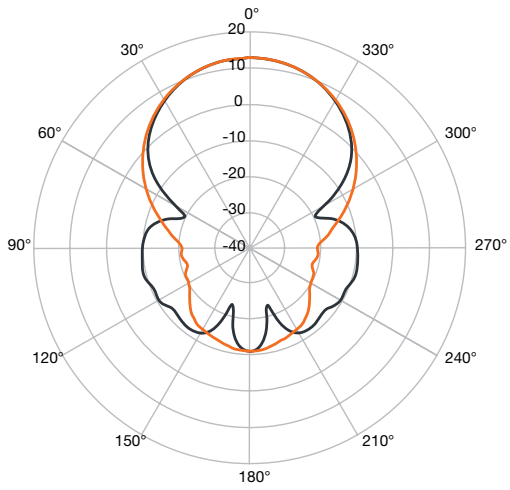

18 GHz

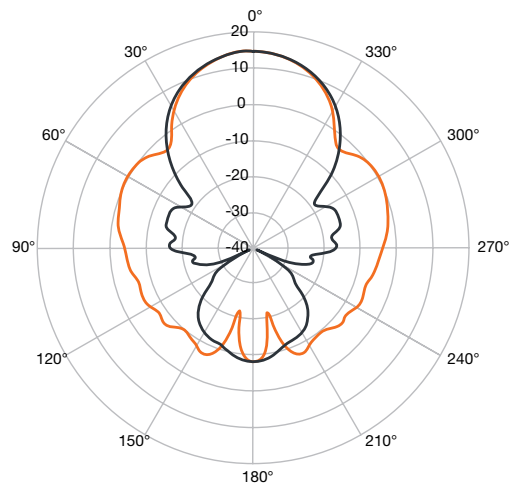

24 GHz

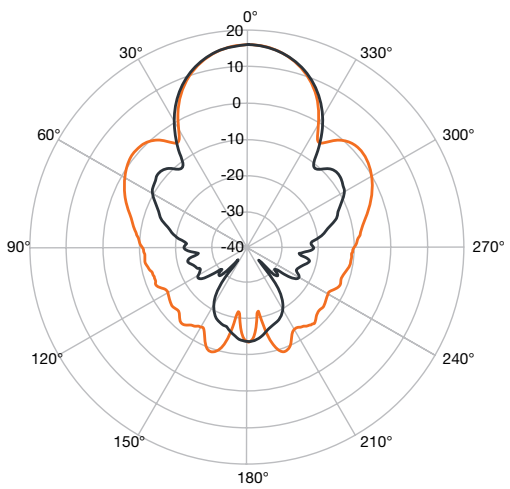

30 GHz

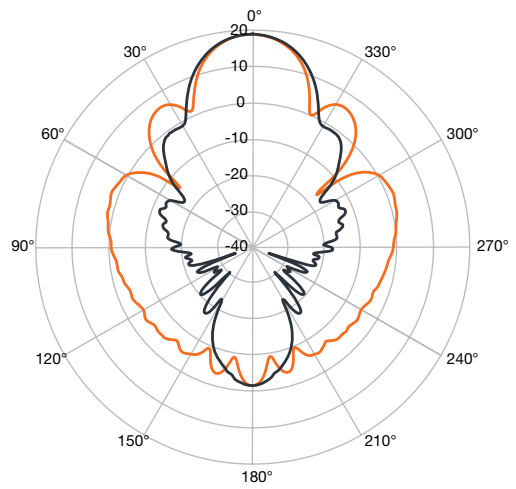

40 GHz

Gain / Antenna factor

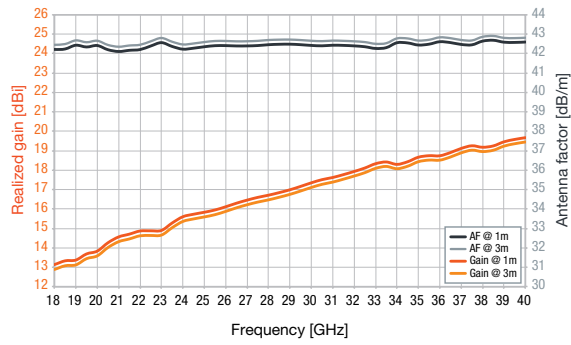

VSWR

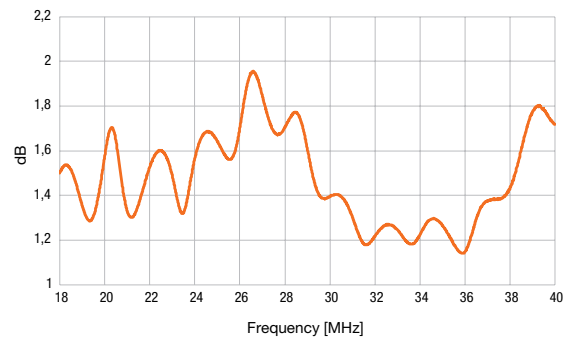

-3 dB beamwidth

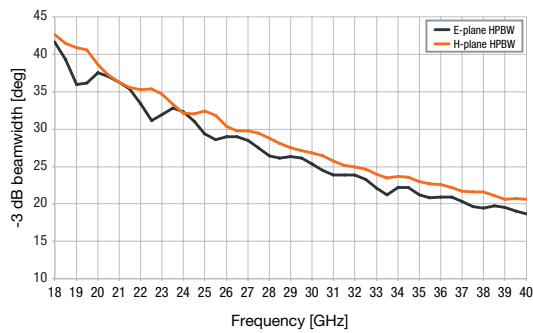

Power handling (CW) / Forward power

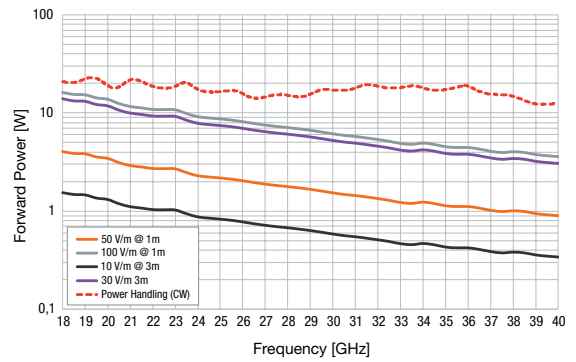

Electrical characteristics

Type of antenna	Dual-Ridge horn
Frequency range	18 – 40 GHz
Realized gain	13 – 19 dBi
Antenna factor	42 – 43 dB/m
E-plane HPBW (2x)	18 – 42 deg
H-plane HPBW (2x)	20 – 41 deg
VSWR	1.1 to 1.9 (average 1.4) : 1
Polarization	Single linear
Impedance	50 Ohms
Power handling (CW)	15 W average

Mechanical characteristics

Dimensions (H x W x L)	7 x 6.5 x 15 cm
Weight (approx.)	0.5 Kg
Material	Aluminum
Surface treatment	Surtec 650®
Coatings	Gray (RAL 7021) Orange (RAL 2009)
RF connector	k Female

Dimensional drawing

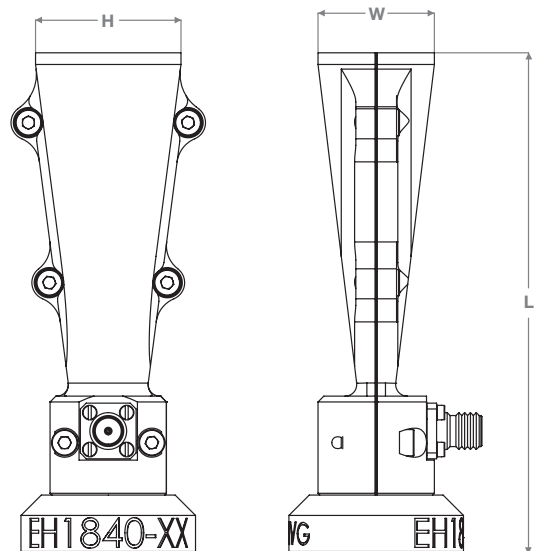

A global presence

Microwave Vision exports more than 90% of its production outside of France. The Group spans Europe, Asia and America through 20 locations in 10 countries.

MVG Industries

17 avenue de Norvège
91140 Villebon-sur-Yvette
FRANCE

Tel: +33 (0)1 69 29 02 47

MVG - Corporate HQ

47, boulevard Saint Michel
75005 Paris
FRANCE

Tel: +33 (0)1 75 77 58 50

MVG Industries Bretagne

Technopole Brest Iroise,
Z.I. du Vernis,
225 rue Pierre Rivoalon,
29200 Brest
FRANCE

Tel: +33 (0)2 98 05 13 34

Orbit/FR Germany

ORBIT/FR Germany
J. S. Bach-Str. 11
85591 Vaterstetten
GERMANY

Tel: +49 (0)810 699 6060

Orbit/FR Israel

1 Geshar Ha-Ets St.,
P.O. Box 12096,
Emek Hefer Industrial Park,
38777-01 Emek Hefer
ISRAEL

Tel: +972 74 713 0130

MVG Italy

Via Castelli Romani, 59
00040 Pomezia (Rome)
ITALY

Tel: +39 06 89 99 53 11

Research and Production center in France



MVG Sweden

P.O. Box 35
44121 Alingsås
Gothenburg
SWEDEN

Tel: +46 31 402 430

Rainford EMC Systems Limited

Unit 400,
Haydock Lane,
Haydock WA11 9TH
UNITED KINGDOM

Tel: +44 (0)1 942 296 190

MVG Hong-Kong

Suite 702, 7th floor
Cyberport 1
100 Cyberport Road
Pok Fu Lam
Hong Kong SAR
CHINA

Tel: +85 229 896 128

MVG India

N° 414 Cunnigham Road
Level 4 Prestige Centre Point,
560052 Bangalore
INDIA

Tel: +91 70 22 98 12 16

Production site in Israel



MVG Japan

#101 Confort Musashi-
Nakahara,
2-10-32, Shimokodanaka,
Nakahara-ku, Kawasaki-city
211-0041 Kanagawa
JAPAN

Tel: +81 44 948 9301

Orbit/FR's Corporate HQ

506 Prudential Road
Horsham, PA
19044
UNITED STATES

Tel: +1(215) 674 5100

MVG, Inc

2105 Barrett Park Dr.,
Suite 104
Kennesaw, GA 30144
UNITED STATES

Tel: +1 678 797 9172

AEMI

1320 Air Wing Road,
Otay Mesa, CA 92154
UNITED STATES

Tel: +1 (619) 449 9492



Contact your local sales representative for more information

www.mvg-world.com

salesteam@mvg-world.com